

Model No.DMC300 76MM CORDLESS COMPACT CUT OFF

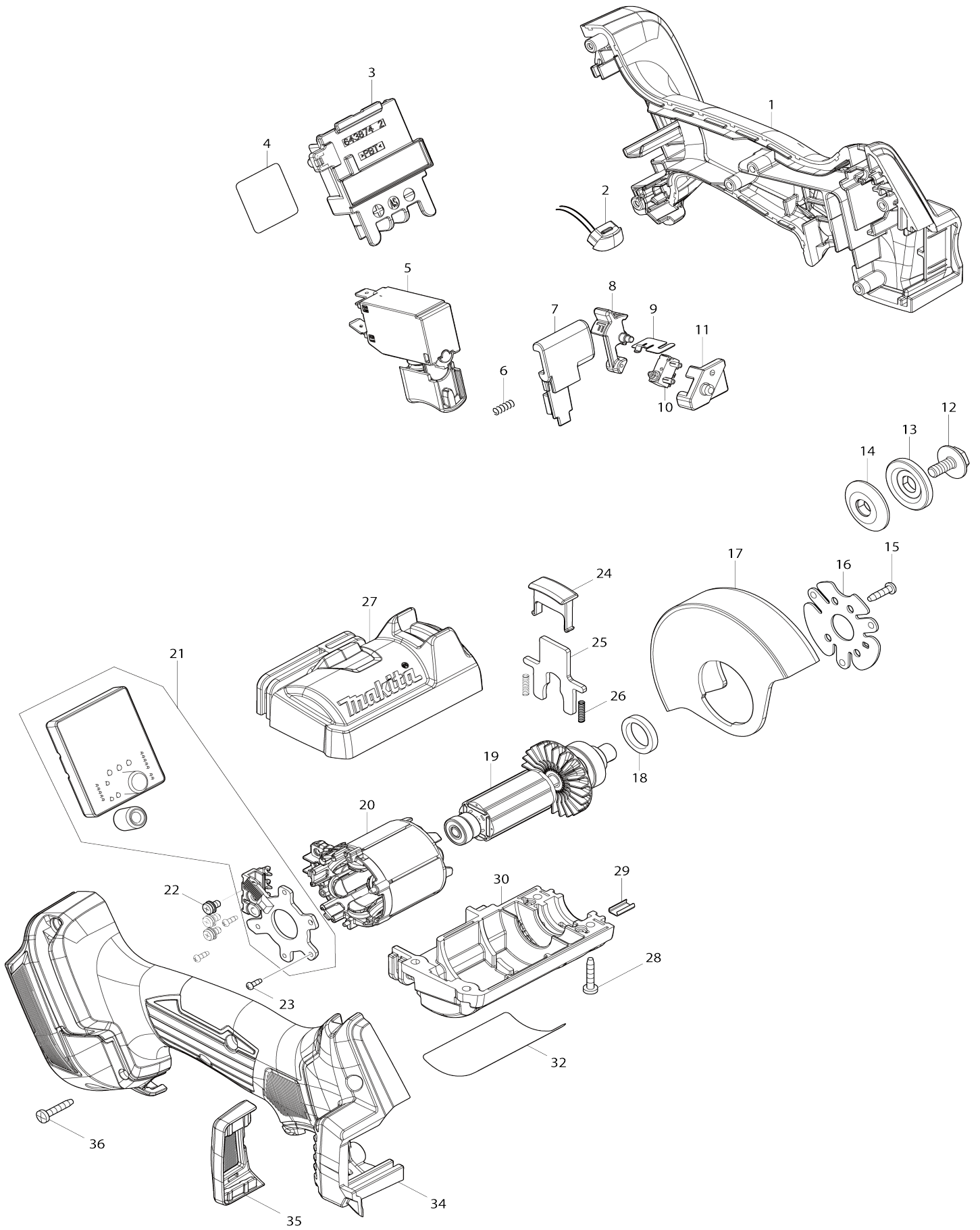

Model No.DMC300 76MM CORDLESS COMPACT CUT OFF

Item No.	Parts No.	Description	Interchangability	Q'ty	New/Old	Note1	Note2
001	183V87-0	HANDLE SET		1			
D10		INC. 34					
002	620549-0	LED CIRCUIT		1			
003	643874-2	TERMINAL		1			
004	8119H1-1	DMC300 SERIAL NO. LABEL		1			
005	650027-6	SWITCH C3JW-4CM-R		1			
006	231433-0	COMPRESSION SPRING 4		1			
007	413F56-4	LOCK OFF BUTTON		1			
008	413F52-2	F/R CHANGE LEVER		1			
009	232747-0	LEAF SPRING		1			
010	632T84-6	SWITCH UNIT		1			
011	413F55-6	SWITCH BASE		1			
012	265C51-0	HEX. SOCKET HEAD BOLT M5X12		1			
013	224624-0	OUTER FLANGE 25		1			
014	224623-2	INNER FLANGE 25		1			
015	266556-5	TAPPING SCREW 3X12		4			
016	347979-7	PLATE A		1			
017	162B46-7	WHEEL COVER 76		1			
018	422870-1	FELT RING 18		1			
019	619755-2	ROTOR		1			
020	629B23-7	STATOR		1			
021	620J17-3	CONTROLLER		1			
022	652069-6	FLAT HEAD SCREW M3X6		3			
023	266490-9	TAPPING SCREW PT 2X6		3			
024	413F51-4	CAP		1			
025	347978-9	SHAFT LOCK		1			
026	232472-3	COMPRESSION SPRING 2		2			
027	183X33-5	MOTOR HOUSING SET		1			
D10		INC. 30					
028	266429-2	TAPPING SCREW 3X16		4			
029	347980-2	PLATE B		1			
030	183X33-5	MOTOR HOUSING SET		1			
D10		INC. 27					
032	8119G4-8	DMC300 NAME PLATE		1			
034	183V87-0	HANDLE SET		1			
D10		INC. 1					
035	422880-8	DUST COVER		1			
036	266429-2	TAPPING SCREW 3X16		6			
A01	122C54-6	DUST COLLECT COVER ATTACHMENT		1			
C10	265760-3	THUMB SCREW M5X10		1			
C20	267010-2	FLAT WASHER 5		1			
C30	413F54-8	CLEAR COVER		1			
C40	265C71-4	TAPPING SCREW 3X6		2			
A02	D-77263	DIAMOND WHEEL 76X10 MM RIM		1	*		
A02-1	D-77263	DIAMOND WHEEL 76X10 MM RIM	O	1			

A03	D-74837	TUNGSTEN CARBIDE GRIT 76X10 MM		1			
A04	D-74815	CUTTING WHEEL/THIN THICKNE SS		1			
A05	783202-0	HEX. WRENCH 4		1			

Please state Parts No. when your order.

Print Date 24/10/2023